

Banseok Precision Industry Co., Ltd.

ENGLISH

PRODUCT CATALOG

THE WORLD'S NEW INTRODUCTION OF THE DISPENSING TECHNOLOGY

PRECISION DISPENSING



www.banseok.co.kr



CONTENTS

- 06 SYSTEM
- 12 CONTROLLERS
- 20 DISPENSING VALVES
- 32 PRESSURE TANKS
- 36 PRESSURE PUMPS
- 40 DISPENSING PUMPS
- 44 GEAR PUMP COMPOUND UNITS
- 46 ROBOTS
- 56 ACCESSORIES
- 71 APPLICATIONS



BANSEOK
PRECISION
INDUSTRY CO., LTD.

1996 Founded in

Banseok Precision Industry has a differentiated production system based on technology and know-how accumulated over 25 years.



Enter more than **20** countries around the world

Banseok is recognized for our global competitiveness, supplying equipment to more than 20 countries around the world, including USA, Germany, Japan, and France.

Partnership with **5,200** domestic companies

Banseok provides the best dispenser equipment to the top domestic companies, including Samsung Electronics, Hyundai Mobis, LG Innotek, Hanwha Q-Cell, etc.

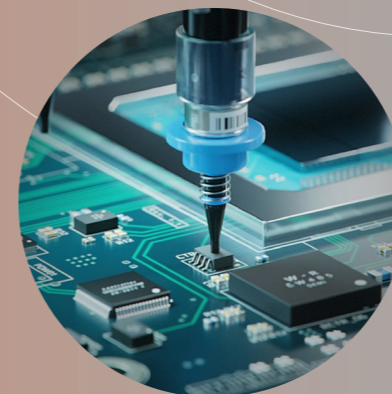

ONE-STOP customizing system

Banseok offers the best solution for customer needs, from customer consultation to equipment design, testing, and after services.

CUSTOMIZING SUPPORT FOR CUSTOMERS

The dispensing system requires professional Know-How to be applied to the application. Different equipment and system should be applied based on the application field, used material, and dispensing accuracy. Banseok supports customers to customize the system depending on the specifications of the customer's need with Banseok's Know-How.

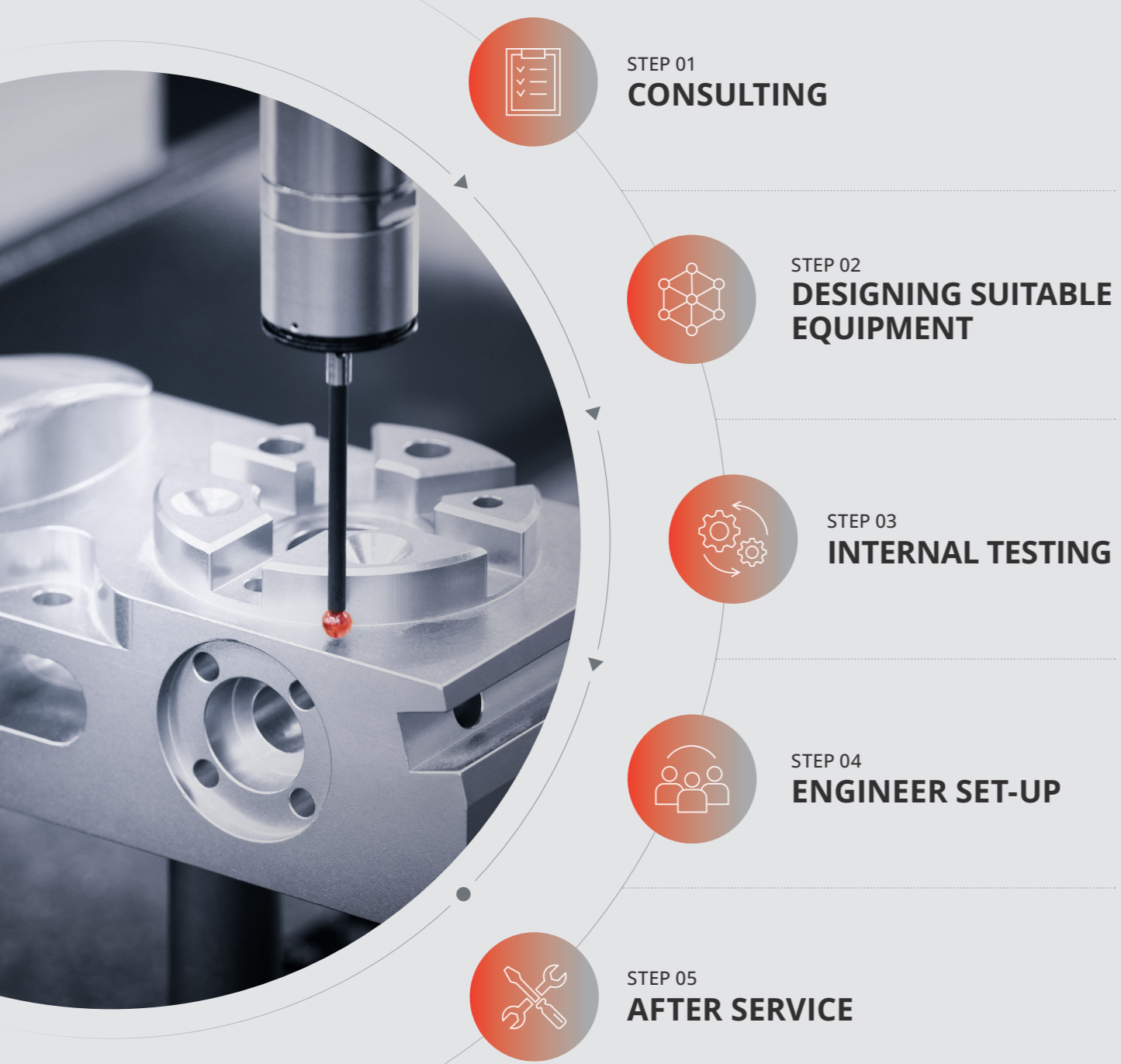

CONCEPT OF VISCOSITY

Dispensing technology applies different controlling methods depending on the material's chemical properties, fluidity, and curing conditions. Therefore, we need to understand the viscosity, dispensing volume, shape, and operation method to use a suitable system for the application. Viscosity particularly can be anticipated referring to the fluid material around us.

Viscosity Graph

The units of viscosity shown in the fluid property table can be converted as below.

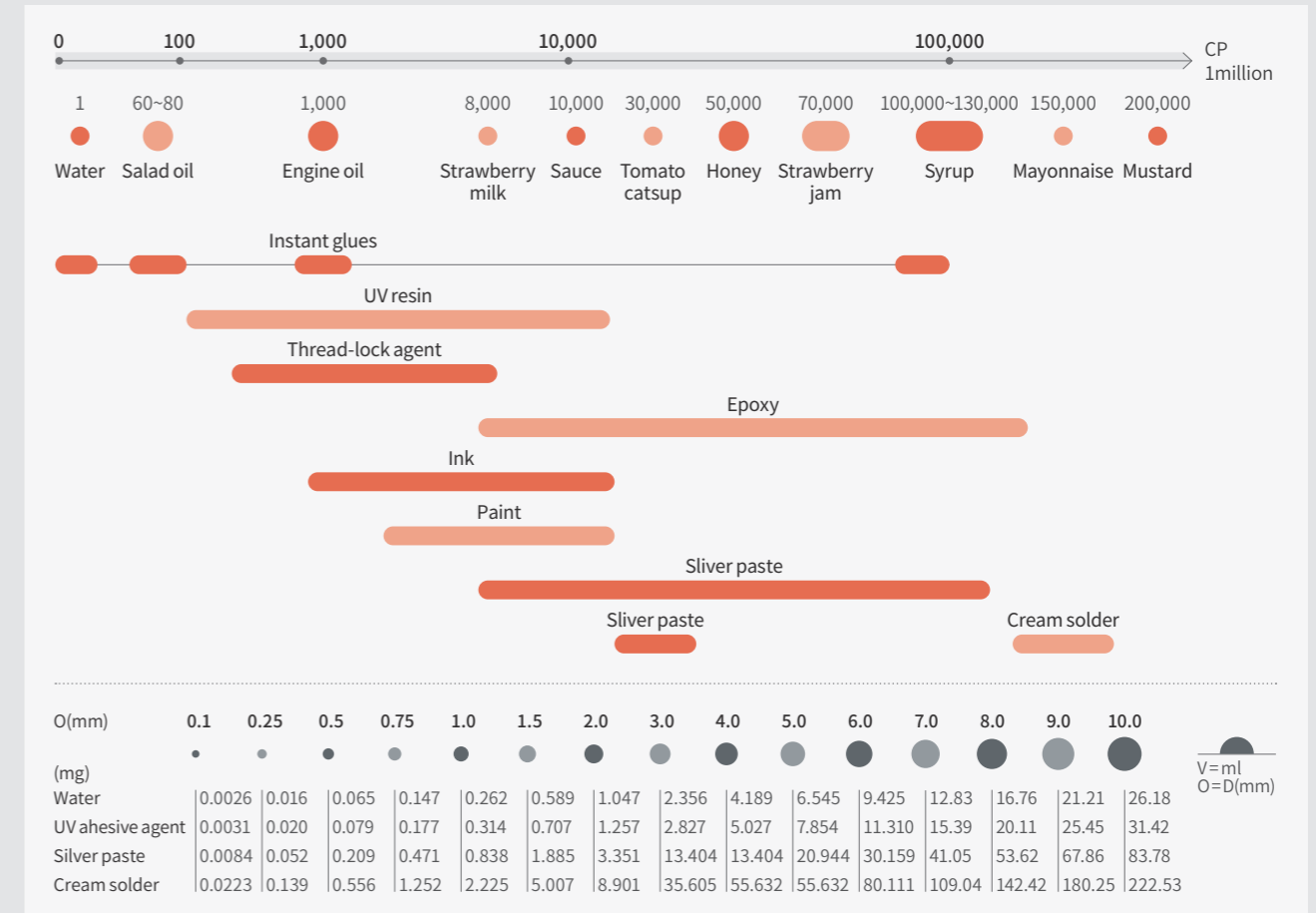

Viscosity Unit Chart

unit	cP	P(g/cm.s)	gmf.s/cm ²	lbf.s/in ²	mPa-s	N.s/m ²
cP	1	0.01	1.02e-7	1.45e-7	1	0.001
P(g/cm.s)	100	1	1.02e-6	1.45e-5	100	0.1
gmf.s/cm ²	98039.2	980.392	1	0.014219	98039.2	98.0392
lbf.s/in ²	6894757	68947.57	70.3265	1	6894757	6894.76
mPa-s	1	0.01	1.02e-7	1.45e-7	1	0.001
N.s/m ²	1000	10	0.0102	1.45e-7	1000	1

Pot Life

- Pot life is a period in which viscosity changes little generally for 100g material, so it is possible to work at a room temperature of 25°C.
- The time it takes to reach twice the initial viscosity, and after this time, the curing accelerates rapidly.

Hardening conditions

- Fluids curing conditions can be natural curing, thermal curing, chemical reaction curing, UV curing, and moisture curing. The dispensing equipments can be chosen after checking these properties.



Dispensing Unit

The unit dispenses the fluid directly to the product. Various types can be selected depending on the dispensed volume, fluid viscosity, specific gravity, and dispensing accuracy.



Controller

The unit controls the operation of the dispensing unit or supplying unit. The controller regulates the dispensing time, volume, and other functions.



Supplying Unit

The unit supplies the fluid material to the dispensing unit. It includes barrel, cartridge, tank, and pressure pumps, that can be chosen regarding the fluid viscosity, specific gravity, and presence of the filler.

SYSTEM

The essential components of the fluid dispensing system include a fluid supplying unit, a controller, and a fluid dispensing unit. With Banseok's standard systems, you can choose the suitable equipments according to the fluid property and application purpose.

TAD-101 SYSTEM



The basic system using controller which regulates the air pressure, and the barrel which is connected directly to the controller. The dispensed amount can be adjusted by given input time, air pressure and the needle size.



Applicable Controller



TAD-200S



TAD-300L



TAD-280L

TAD-102 SYSTEM



Similar to TAD-101, the system dispenses larger amount of fluid using cartridge or cartridge type material placed in cartridge holder.



TAD-103 SYSTEM



Applicable Controller



TAD-200S



TAD-300L



TAD-280L

The system dispenses materials in the barrel or the cartridge using dispensing valve to meet high accuracy and to remove fluid dripping due to a remaining pressure after dispensing.



TAD-104 SYSTEM



The system dispenses materials in the pressure tank, using dispensing valve and controller. This system holds a large amount of material, therefore suitable for an application dispensing a large amount at a time or frequently filling the container.

TAD-105 SYSTEM



The system dispenses fluid materials of high viscosity using pressure pump.

Can-type fluid material goes directly to the pressure pump and controlled by the valve and the controller.



CONTROLLER

DISPENSING CONTROLLER

TAD-200S

Single action type controller

Controller for barrel, cartridge, and single action type valve.

This single action type controller has convenience functions for users including interval timer, vacuum control, digital timer, and memorizing function, etc.

- * Interval Timer – Functions including automatic dispensing, automatic stop, etc are available by setting time.
- * Vacuum Control – Dripping phenomenon of low-viscosity fluid after dispensing can be prevented using vacuum control function.
- * Digital Timer – The digital timer displayed on LED in manual mode.
- * Memorizing function – Memorizes the values for dispensing until setting values again.



TAD-200V

Double action type controller

This controller has the same function as TAD-200S and is suitable for double action type valves.



Model	TAD-200S
Control Method	Electronic / Pneumatic System
Dispensing pressure	0~10kg/cm ² (S: Standard) 0~4kg/cm ² (L: Option) 0~2kg/cm ² (P: Option)
Time Range	0.01~99.99 sec
Interval Timer	0.01~99.99 sec
Vacuum Pressure	0~ -350mmHg
Out Signal	Open connector, DC 24V 20mmsec (Relay), 100mmsec (Relay)
Power Source	AC220V 50/60Hz (AC100V 50/60Hz: Option)
Power Consumption	32W
External Dimension & weight	232(W) x 186(D) x 81(H)mm, 2.7kg

Model	TAD-200V
Control Method	Electronic / Pneumatic System
Dispensing pressure	0~10kg/cm ² (S: Standard) 0~4kg/cm ² (L: Option) 0~2kg/cm ² (P: Option)
Time Range	0.01~99.99 sec
Interval Timer	0.01~99.99 sec
Out Signal	Open connector, DC 24V 20mmsec (Relay), 100mmsec (Relay)
Power Source	AC220V 50/60Hz (AC100V 50/60Hz: Option)
Power Consumption	32W
External Dimension & weight	232(W) x 186(D) x 81(H)mm, 2.7kg

CONTROLLER

DISPENSING CONTROLLER

TAD-280L

High quality version of TAD-200S

This high quality version of TAD-200S has reduced error rate from previous 20% to 3%, and 50% improved dispensing reaction time, a more precise time setting function of 0.001sec, and little noise due to high quality silencer.



Model	TAD-280L
Control Method	Electronic / Pneumatic System
Dispensing pressure	0~10kg/cm ² (S: Standard) 0~4kg/cm ² (L: Option) 0~2kg/cm ² (P: Option)
Time Range	0.01~99.99 sec
Pattern Channel	1~10 Channels
Memory Function	500 memories
Display Section	LCD digital display
Input / Output Signal	Open connector, DC 24V
Out Signal	Open Collector, DC 24V
Power Source	AC220V 50/60Hz (AC100V 50/60Hz:Option)
External Dimension & weight	176(W) x 154(D) x 72(H)mm, 2.4kg

Model	TAD-300L
Control Method	Electronic / Pneumatic System
Dispensing pressure	0~10kg/cm ² (S: Standard) 0~4kg/cm ² (L: Option) 0~2kg/cm ² (P: Option)
Time Range	0.01~99.99 sec
Vacuum Pressure	0~ -350mmHg
Out Signal	Open connector, DC 24V
Power Source	AC220V 50/60Hz (AC100V 50/60Hz:Option)
Power Consumption	6W
External Dimension & weight	176(W) x 154(D) x 72(H)mm, 2.4kg



TAD-300L

Time calibration type controller

This controller has the same function as TAD-280L, but improved time calibration function to 0.001sec. TAD-300L enables the digital time setting, thus more accurate time setting with LCD Digital Display is possible.



CONTROLLER

VACUUM PICK-UP CONTROLLING DISPENSER

TAD-200SP

Vacuum pick-up controller

This controller has the same function as TAD-200S and added vacuum system for Pick-Up pen. It makes easy assembly of small components and repairing/reworking using its own pick-up pen: MN-5. The vacuum rate can be controlled according to the product size&weight.



Model	TAD-200SP
Control Method	Electronic / Pneumatic System
Time Range	0.01~99.99 sec
Interval Timer	0.01~99.99 sec
Vacuum Pressure	0~ -350mmHg
Out Signal	Open connector, DC 24V 20mmsec(Relay)
Power Source	AC220V 50/60Hz (AC100V 50/60Hz:Option)
Power Consumption	32W
External Dimension & weight	282(W) x 186(D) x 81(H)mm, 3.0kg



SPRAY VALVE CONTROLLER

TAD-500SR

Conformal coating valve controller

This controller regulates the air blow and fluid dispensing of the conformal coating valve. With the introduction of precise regulator, 0.001MPa can be adjusted. The digital display and simple interface enables convenient&precise setting.



Model	TAD-500SR
Control Method	Electronic / Pneumatic System
Time Range	5bar/20ms
Interval Timer	0.01~99.99 sec
Out Signal	DC24V, 2.5A
Power Source	220V, 1A, 50/60Hz
External Dimension & weight	260(W) x 135(D) x 95(H)mm, 3.0kg



CONTROLLER

HEATER CONTROLLER

EZ TEM-3

Heating Controller

This controller provides the heating solution that makes fluid viscosity appropriate to be dispensed.



Model	EZ TEM-3
Indication Accuracy	±0.3% of indication value or ±3°C, whichever is greater
Control Method	ON/OFF or P,PI,PD,PIDF,PIDS
Indication Method	7Segment LED display [PV: RED, SV: GREEN]
Control Sensitivity	1~100(0.1~100.0)°C Variable, when using ON/OFF control
Temperature Range	Low-Temperature: Room temperature~80°C/ High-Temperature: Room temperature~200°C
Power Source	AC110-240V 50/60Hz
External Dimension & Weight	121(W) x 150(D) x 65(H)mm

PROGRESSIVE CAVITY PUMP CONTROLLER

BP-2

Progressive Cavity Pump Controller

A BPP-Series controller which controls the motor connected to the Rotor. It controls the motor speed to maximum 120rpm for the both shot and suck-back function. With the Real&Time mode, ON/OFF control or time setting control are available.



Model	BP-2
Interface	RS485(Male), D-SUB 9 pin
Input/Output Signal	Shot, Channel No, User Optional / End Signal, Error Signal
Air IN-Port	6Ø Air Hose
Air OUT-Port	Auto Coupler
Pressure Regulator	0~7kgf/cm ²
Operation Mode	Time / Real
Display	4.3" TFT LCD, Touch Panel
Motor	DC Servo Motor
External Control	Input 8 CH, Output 8 CH
Channel Memory	Internal: 200 CH, External: 16 CH
Consumption Rating	AC 80~220V(Pre Volt), 50/60Hz
Operating Temperature	10~40°C
Optional System	Dispensing Pressure Check (for 2 Parts only)
Dimension & Weight	220(W) x 224(D) x 120(H)mm / 1.8kg

TUBING DISPENSING CONTROLLER

BX-2

Tubing Dispenser

This controller is volumetric tubing dispenser which is not using air pressure but its rotating pump head pushes the fluid material in the tube and dispense precise amount of the material. The tube goes directly in the fluid container, and the fluid in the tube is dispensed due to the pressure difference made by pump head rotation. The controller is suitable for the low viscosity and anaerobic fluid material application.



Model	BX-2
Control Method	Electronic / Pneumatic System
Dispensing pressure	0.15kg/cm ²
Time Range	0.01~99.99 sec
Rotor Speed	0~120rpm(max.)
Flow Speed	0.01~6ml/min.(Teflon Tube) 0.1~20ml/min.(Silicone Tube)
Material Viscosity	300cps(max.)
Pump Direction	Both Direction(Forward & Reverse)
Power source	AC100~220V 50/60Hz(Free voltage)
External Dimension & weight	190(W) x 165(D) x 81(H)mm, 2.6kg

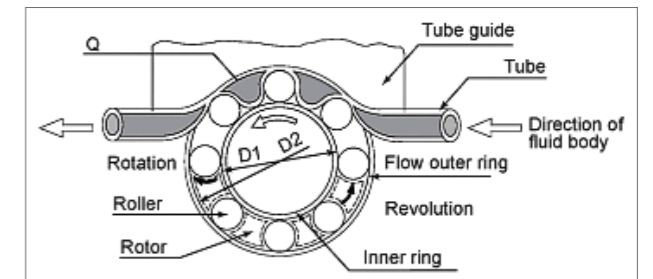

DISPENSING VALVE

NEEDLE-OFF VALVE

The valve operates as the needle-shaped pin stuck in the fluid outlet falls off.
 This type of valve does not make the Head: A clumped fluid material made at the beginning of the line dispensing. Needle Off type is often used for the high pressure valve.

BV-302

The basic valve of Needle-Off type.
 Suitable for the low-medium viscosity fluid material, where application requires small amount dispensing.



BV-386

Needle Off type valve for the high viscosity.
 Suitable for the application using high pressure&high viscosity fluid material of 1cps~paste.

BV-3893

Large capacity version of BV-386.



BV-3892

Larger orifice size version of BV-3893.
 Suitable for the application where big amount dispensing is required.

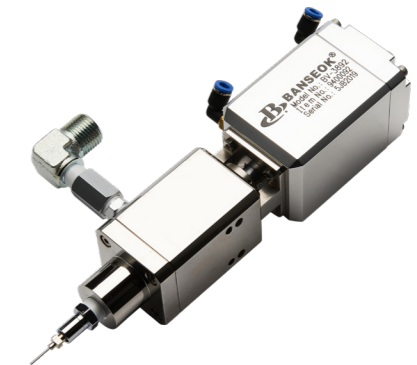

Model	BV-302	BV-386	BV-3892	BV-3893
ON/OFF Method	Needle Off	Needle Off	Needle Off	Needle Off
Applicable viscosity	1~100,000cps	1~PASTE	1~1,000,000cps	1~1,000,000cps
Input Air Pressure	4kgf/cm ²	5kgf/cm ²	5kgf/cm ²	5kgf/cm ²
Max. fluid IN-LET pressure	6kgf/cm ²	150kgf/cm ²	210kgf/cm ²	210kgf/cm ²
Max. operation number	150times/min	150times/min	150times/min	240times/min
IN-LET Fittings	PT 1/8"	PT 1/4"	PT 1/2"	PT 1/4"
Wet-part material	SUS 303	SUS 303	SUS 303	SUS 303
Valve material	AL 6061	AL 6061	AL 6061	AL 6061
Weight	290g	680g	2540g	820g

DISPENSING VALVE

PRECISION VALVE

A needle off type valve for small amount, low viscosity fluid dispensing, designed to set the fine dispense amount by adjusting the pin stroke of the valve.

BV-520M

A precision valve.

The stroke of the needle pin is adjustable, therefore precise amount dispensing is available.



BV-520P

Precision Nozzle version of BV-520.



BV-520PK

BV-520 valve used for anaerobic UV material & adhesive application. The valve is suitable for the anaerobic fluid material due to PEEK material applied to a wet part. Both needle type or precision nozzle type can be used.



Model	BV-520M	BV-520P	BV-520PK
ON/OFF Method	Needle Off	Needle Off	Needle Off
Applicable viscosity	1~100,000cps	1~100,000cps	1~100,000cps
Input Air Pressure	5kgf/cm ²	5kgf/cm ²	5kgf/cm ²
Max. fluid IN-LET pressure	10kgf/cm ²	10kgf/cm ²	6kgf/cm ²
Max. operation number	240times/min	240times/min	240times/min
IN-LET Fittings	PT 1/8"	PT 1/8"	PT 1/8"
Wet-part material	SUS 303	SUS 303	PEEK
Valve material	SUS 303	SUS 303	SUS 303
Weight	300g	300g	300g

DISPENSING VALVE

SUCK BACK VALVE

The valve operates as the fluid outlet is closed by pulling the pin, dispensed as the pin falls off. This type of valve does not make the Tail: A clumped fluid material made at the end of the line dispensing. Often used in applications that require vacuum process to remove the remaining pressure after dispensing.

BV-303

Basic type of Suck Back valve.
Suitable for the low-midium viscosity fluid material, where application requires small amount dispensing.



BV-325

Large capacity version of BV-303.



BV-396

Larger orifice size version of BV-325.
Suitable for the high pressure & high viscosity application up to 500,000cps.

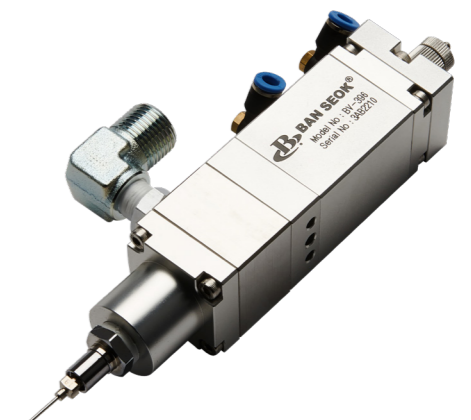

Model	BV-303	BV-325	BV-396
ON/OFF Method	Suck Back	Suck Back	Suck Back
Applicable viscosity	1~200,000cps	1~200,000cps	1~500,000cps
Input Air Pressure	5kgf/cm ²	5kgf/cm ²	5kgf/cm ²
Max. fluid IN-LET pressure	30kgf/cm ²	50kgf/cm ²	150kgf/cm ²
Max. operation number	150times/min	150times/min	150times/min
IN-LET Fittings	PT 1/8"	PT 1/4"	PT 3/8"
Wet-part material	AL 6061	AL 6061	AL 6061
Valve material	AL 6061	AL 6061	AL 6061
Weight	240g	300g	300g

DISPENSING VALVE

SPRAY VALVE

A Conformal coating valve with the spraying function. The valve operates as the needle off function and sprays the dispensed fluid with internal air blow function. Products can be selected according to the application and required scattering degree.

BV-500 ①

A spray dispensing valve.
The valve can control the spraying width of minimum 7mm according to the height.



①

BV-500T ②

A precise spraying valve with little scattering. The “Tornado” technology is applied on the valve, therefore provide more precise spray dispensing.



②

BV-500P ③

Conformal coating valve with uniform spraying with improved internal airflow structure. To treat the quick-curing conformal coating fluid, the nozzle is placed inside the valve, therefore, providing an equal dispensed shape, and is easy to clean when cured.

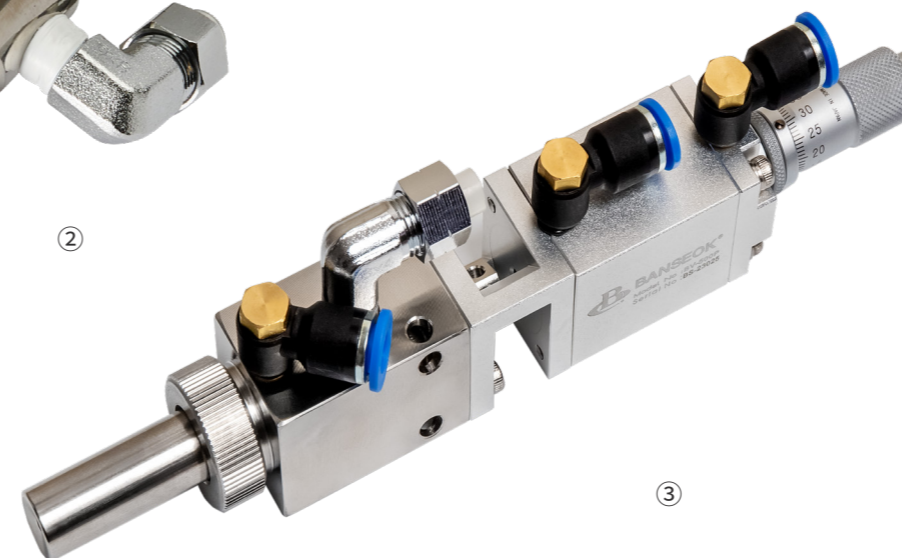

③

Model	BV-500	BV-500T	BV-500P
ON/OFF Method	Needle Off	Needle Off	Needle Off
Applicable viscosity	1~1,000cps	1~1,000cps	1~1,000cps
Input Air Pressure	5kgf/cm ²	5kgf/cm ²	5kgf/cm ²
Max. fluid IN-LET pressure	10kgf/cm ²	10kgf/cm ²	10kgf/cm ²
Max. operation number	240times/min	240times/min	240times/min
IN-LET Fittings	PT 1/8"	PT 1/8"	PT 1/8"
Wet-part material	SUS 303	SUS 303	SUS 303
Valve material	SUS 303	SUS 303	SUS 303
Weight	285g	340g	400g
Control	-	-	Double-Action
Stroke Control	-	-	Micrometer

DISPENSING VALVE

METERING VALVE

A precise metering valve with a dispensing error rate of 1%.
The valve has the volume metering principle that measures required volume and dispense in even amount.

BV-M0250T

Precise metering valve with a shot size minimum 0.025cc to maximum 0.25cc. Suitable for the low viscosity, small amount application.

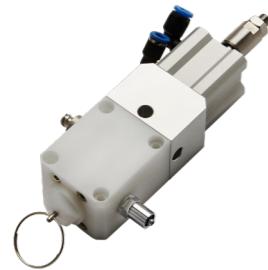

BV-M06

A precision metering valve for high viscosity with a dispensing error rate of 1%. A shot dispenses minimum 0.2cc to 6cc.

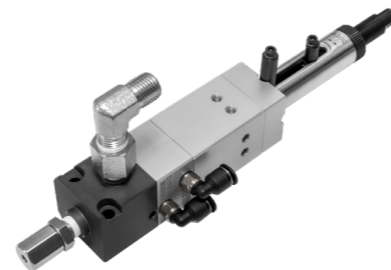

Model	BV-M0250T	BV-M06
ON/OFF Method	Metering	Metering
Applicable viscosity	1~5,000cps	MAX 1,000,000cps
Input Air Pressure	4kgf/cm ²	2~7kgf/cm ²
Max. fluid IN-LET pressure	4kgf/cm ²	250kgf/cm ²
Max. operation number	180times/min	90cycle/min
IN-LET Fittings	PT 1/4"(in), PT 1/8"(out)	PT 1/8"
Wet-part material	SUS 304	SUS 304
Valve material	AL 6061	AL 6061
Weight	700g	420g
Accuracy	.+- 1%	.+- 1%

ACTUATOR VALVE

The valve is controlled in rotary principle, therefore there is no Head or Tail which is clumped fluid material made during the line dispensing.

BV-600C

An actuator valve removes the remaining pressure after dispensing and prevents dripping of the fluid at the end of the needle.

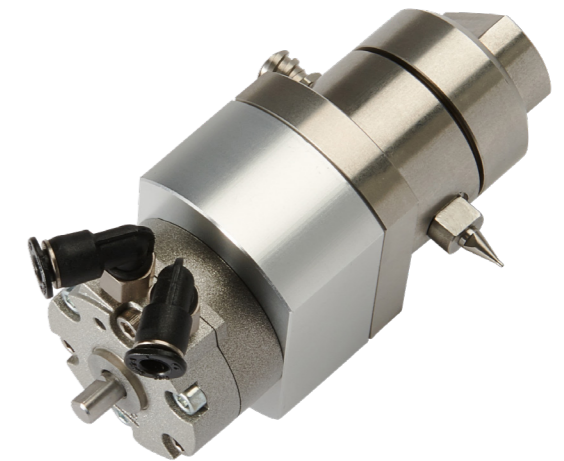

Model	BV-600C
ON/OFF Method	Rotary
Applicable viscosity	10,000~600,000cps
Input Air Pressure	5kgf/cm ²
Max. fluid IN-LET pressure	21kgf/cm ²
Max. operation number	150times/min
IN-LET Fittings	PT 5/16",M6
Wet-part material	Ceramic
Valve material	AL 6061
Weight	420g

DISPENSING VALVE

DIAPHRAGM VALVE

A valve for low viscosity and low pressure, using diaphragm operation. A fluid hole and the round plate-shaped diaphragm fit in the valve. The valve opens when these fall off and closes when these meet. The material of the diaphragm is suitable for anaerobic and chemical-resistant material.

Model	BV-300N	BV-300T
ON/OFF Method	Diaphragm	Diaphragm
Applicable viscosity	1~5,000cps	1~5,000cps
Input Air Pressure	4kgf/cm ²	4kgf/cm ²
Max. fluid IN-LET pressure	5kgf/cm ²	5kgf/cm ²
Max. operation number	240times/min	240times/min
IN-LET Fittings	PT 1/8"	PT 1/8"
Wet-part material	UPE	TEFLON
Valve material	AL 6061	AL 6061
Weight	76g	76g

BV-300N

A diaphragm valve which is suitable for the anaerobic fluid due to applied UPE material on the valve. Suitable for the low viscosity fluid material.



BV-300T

A diaphragm valve which is suitable for the anaerobic, chemical resistant and UV material that applied Teflon to the wet part. Suitable for the low viscosity fluid material.



TWO LIQUID TYPE VALVE

A two-fluid type valve to dispense 2K materials of resin and hardener. The valve is designed to fasten various types of mixers to the fluid outlet, so the valve can be used after replacing mixers without additional cleaning. Two types can be selected depending on the dispensing amount.

Model	BV-T900	BV-T900-MINI
ON/OFF Method	Suck Back	Suck Back
Applicable viscosity	1~PASTE	1~PASTE
Input Air Pressure	5kgf/cm ²	5kgf/cm ²
Max. fluid IN-LET pressure	60kgf/cm ²	60kgf/cm ²
Max. operation number	60times/min	60times/min
IN-LET Fittings	PT 1/4"	PT 1/4"
Wet-part material	AL 6061	AL 6061
Valve material	AL 6061	AL 6061
Weight	1040g	413g

BV-T900

A two-fluid type suck back valve for high viscosity material.

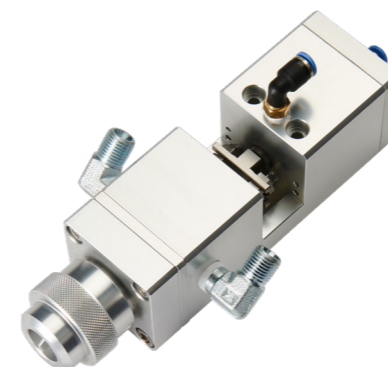

BV-T900-MINI

A compact size version of BV-T900. Suitable for the small amount dispensing.

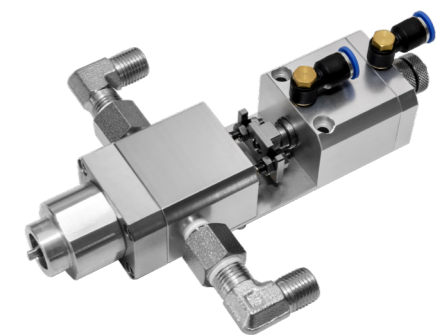

PRESSURE TANK

CUSTOMIZING

A customized tanks with Banseok Precision's customizing system.

The Tank is a large volume fluid container for low-medium viscosity fluid material.

It is used for applications that require large volume dispensing or frequent filling of materials.

Various types and options can be selected depending on the application.



1 Tank Type

BMT / BST / BFT

2 Volume

BMT: Customizing

BST: Max 20L

BFT: Max 8L

3 Port

BP: Bottom Port

TP: Top Port

4 L/S/V

L: Level Gauge (Ø6, Ø8 PFA Tube)

S: Level Sensor, Float Sensor

V: Vision

5 Heater

TANK OPTION

Teflon Coating

Teflon Coating can be selected for applications that require chemical resistance, such as anaerobic fluid material.



Hopper (supplementary fluid filler)

An auxiliary fluid inlet to make fluid materials filling more convenient. Used to simplify the process of opening and closing the heavy clamps of large-volume tanks.



Internal Container

Internal container can be installed for user convenience of fluid filling, cleaning, and stirring.



Vacuum Agitator

An option to vacuum the pressure of the tank to remove air bubbles from the fluid material. Applied to the tank when the fluid material is not in low viscosity.



Load Cell System

A scale system that measures the amount of material. Various resolutions and specifications are selectable depending on the weight and size.



Tank Heater

A Heating option to prevent hardening of the fluid in the containers or to reduce the viscosity.



PRESSURE TANK

The suitable tank among three types can be selected depending on the amount and viscosity of the fluid material in the tank used for the application. You can customize the options you need to each tank types.



①



②



③

BFT Type ①

Simple clamp type tank to transfer low viscosity fluid material.



BST Type ②

Vertical shaped tank used for fluid material under 20L volume.



BMT Type ③

Hinge clamp type tank used for the large volume, high pressure application.



PRESSURE PUMP

CARTRIDGE PUMP

BSP-330S

A device to supply high viscosity cartridge-type fluid without exposure to air or loss of materials using a pump pressure.

Model	BSP-330S
Air pressure	Min. 2kgf/cm ²
Air consumption	80ml/min(max)
Pump sending ratio	10:1, 20:1(For high pressure)
Max. dispensing pressure	50kgf/cm ²
Min. dispensing pressure	0.005cc/shot
Applied viscosity	10,000~600,000cps
Applied container	300ml,310ml,330ml cartridge
Power	AC220V 50/60Hz (110V:Option)



BSP-330D

A dual cylinder type device that supplies high viscosity cartridge-type fluid material without exposure to air or loss of materials using a pump pressure. Once the fluid material in the cartridge 1 is used up, the pump automatically supplies the fluid in the cartridge 2, therefore continuous operation is possible during the cartridge replacement.

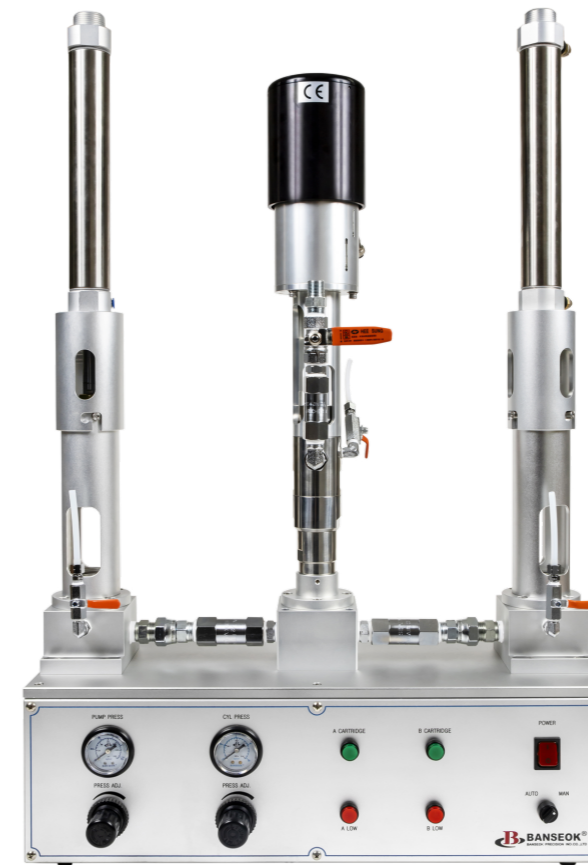

Model	BSP-330D
Air pressure	Min. 2kgf/cm ²
Air consumption	80ml/min(max)
Pump sending ratio	10:1, 20:1(For high pressure)
Max. dispensing pressure	50kgf/cm ²
Min. dispensing pressure	0.005cc/shot
Applied viscosity	10,000~600,000cps
Applied container	300ml,310ml,330ml cartridge
Power	AC220V 50/60Hz (110V:Option)

PRESSURE PUMP

CAN PUMP

PCP-a135

A can pressure pump to transfer the compressed high viscosity fluid material in 1,3,5kg can.

Model	PCP-a135
Pump Sending Ratio	10:1, 20:1(For high pressure)
Applying Viscosity	10,000~400,000cps
Air Pressure	1~7bar
Air Consumption	80ml/min(max)
Applying Container	1kg, 3kg, 5kg
Power	AC220V 50/60Hz(110V:Option)

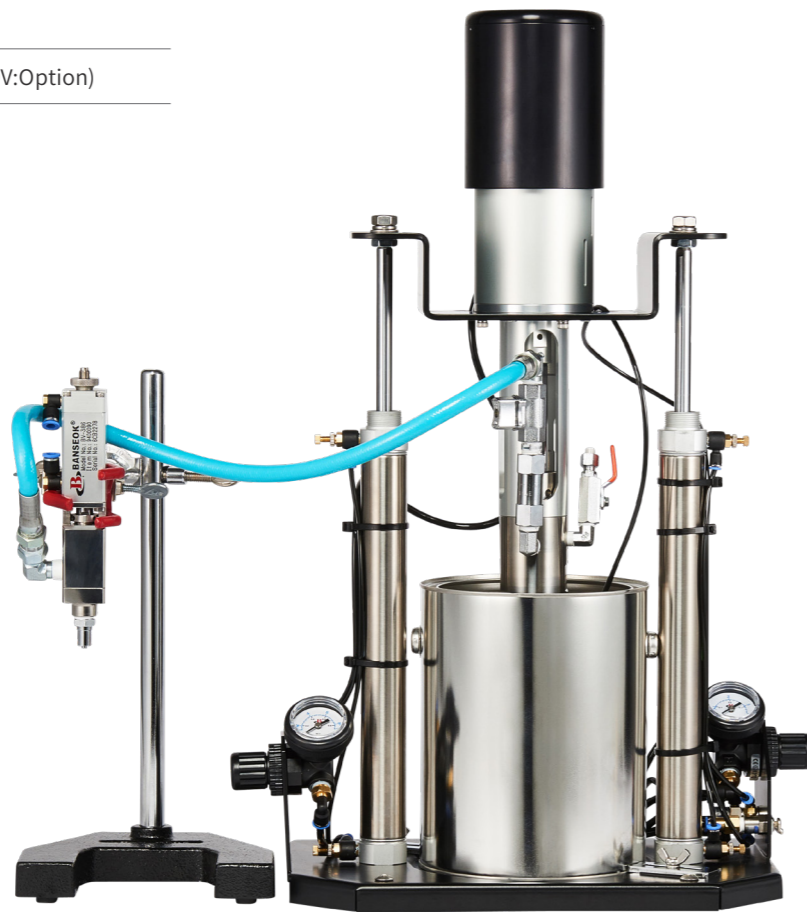

PCP-20-10

A can pressure pump to transfer the compressed high viscosity fluid material in 20kg can with the pneumatic pressure of 10:1 pump sending ratio. It can be applied up to 400,000cps of high viscosity fluid.



Model	PCP-20-10
Pump Sending Ratio	10:1, 20:1(For high pressure)
Applying Viscosity	10,000~400,000cps
Air Pressure	1~7bar
Air Consumption	80ml/min(max)
Applying Container	-
Power	AC220V 50/60Hz(110V:Option)



PRESSURE PUMP

CAN PUMP

PCP-20-55

A can pressure pump to transfer the compressed high viscosity fluid material in 20kg can with the pneumatic pressure of 55:1 pump sending ratio. It can be applied to minimum 50,000cps to maximum 1,000,000cps of high viscosity fluid.

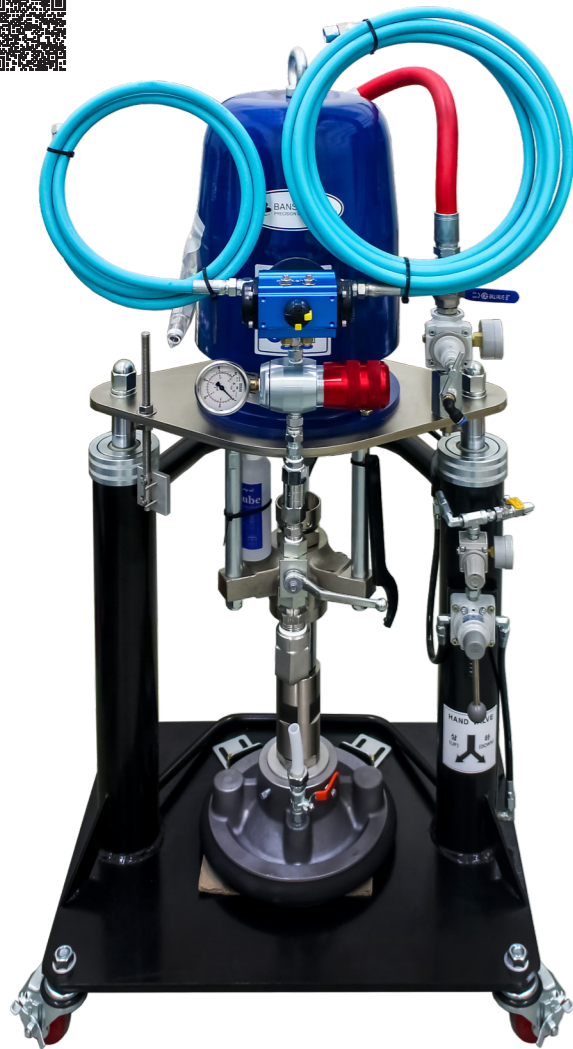

Model	PCP-20-55
Pump Sending Ratio	55:1
Delivery	10L/Min
Air Pressure	3~7bar
Cycle Per Liter	263 Cycle/L
Max. Working Pressure	385bar
Max. Pump Speed	60Cycle/Min
Air Motor Dia	161mm
Stroke	90mm

PUMP ACCESSORIES

AOPR

AOPR is a pneumatic fluid pressure regulator with enhanced performance than FPR, which adjusts the pulsation of high-pressure fluid materials from the pump to around 5% of error rate.

Model	AOPR
Actuation Type	Air
Flow control Type	Regulation
Gauge Port Size (in)	3/4
Gauge Port Type	NPT
Inlet Size	3/4
Inlet Thread Type	NPT
Maximum Regulated Pressure (Mpa)	31.0
Maximum Regulated Pressure (psi)	4,500
Maximum Viscosity (cP)	80,000
Maximum Working Pressure (Mpa)	34.4



FPR

The FPR is a fluid pressure regulator that controls the pulsation of the high pressure fluid material from the pump and reduces the pressure to a suitable and safe pressure for use in subsequent stages of dispensing.

Model	FPR
Maximum Inlet Pressure	
Governing Field	70 - 320bar (1,000-5,000 psi) (RED) 20 - 70bar (0-1,000 psi) (BLUE)
Maximum Delivery	8 Liter/min (2.1 gallon per min)
Fluid Inlet	3/8" NPT(F)
Fluid Outlet	1/4" NPT(F)



DISPENSING PUMP

PROGRESSIVE CAVITY PUMP

Banseok Smart PC Pump is a volumetric dispensing pump with dispensing error rate of less than 1% using a stator and a rotor.

With the Motor Pulse Control and Suck Back functions, fluids of various viscosity up to 100,000 cps can be controlled with its own controller and pump without remaining pressure after dispensing.

A compact size and the intuitive structure enables customers to disassemble and clean easily.



BPP-050



BPP-100



BPP-500



BPP-1000

ENDLESS PISTON PRINCIPLE

Banseok PC Pump are based on a completely pressure tight displacement system, which is self-sealing and consists of a rotor and stator. The controlled motor enables a constant volume to be conveyed proportionally to the angle per revolution.

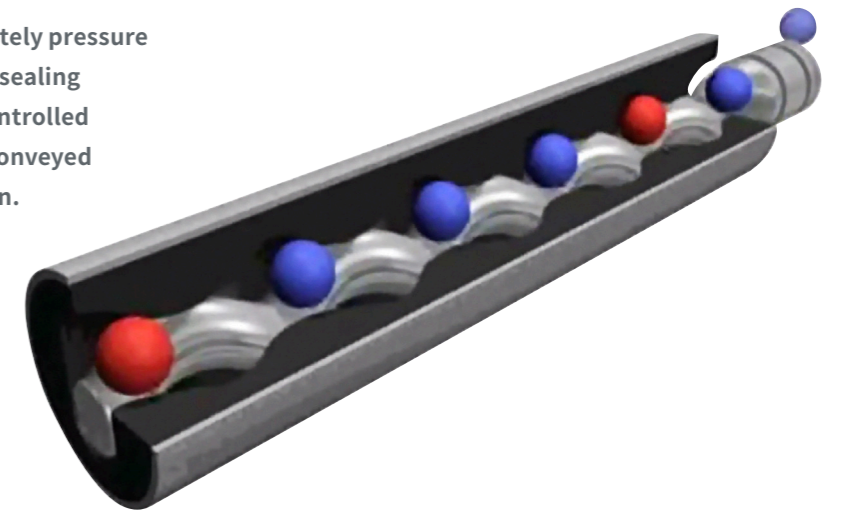

Model	BPP-050	BPP-100	BPP-500	BPP-1000
Dispensing Volume(60rpm/sec)	≒0.05ml	≒0.1ml	≒0.5ml	≒1ml
Motor Speed	1~120rpm	1~120rpm	1~120rpm	1~120rpm
Accuracy	±1%	±1%	±1%	±1%
Input Air Pressure	0~6kgf/cm ²	0~6kgf/cm ²	0~6kgf/cm ²	0~6kgf/cm ²
Material of Stator	FFKM	FFKM	FFKM	FFKM
Material of Motor	Stainless Steel	Stainless Steel	Stainless Steel	Stainless Steel
Inlet Port	G 1/8"(STD)	G 1/4"(STD)	G 1/8"(STD)	G 1/4"(STD)
Outlet Port	Luer Lock	Luer Lock	Luer Lock	Luer Lock
Wetting Part Material	SUS / UHMW-PE	SUS / UHMW-PE	SUS / UHMW-PE	SUS / UHMW-PE
Weight	540g	1.6kg	540g	1.6kg
Operating Condition	10~40°C	10~40°C	10~40°C	10~40°C

DISPENSING PUMP

GEAR PUMP

A volumetric pump which operates with the two gears engaged. The cavity generated between them dispenses even amount per cycle. Fluid of various volumes can be precisely controlled with a dispensing error of less than 1%.

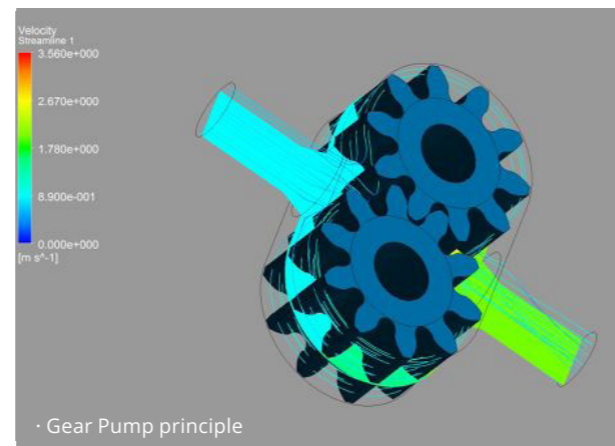
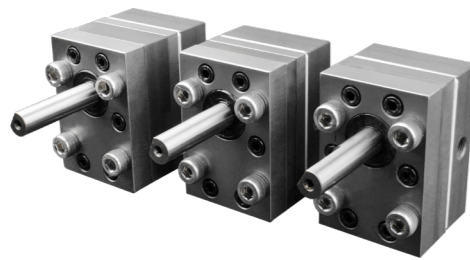

MMA

The Unit dispenses the dual cartridge type fluid material of diverse viscosity with precise control using SERVO/STEP motor and the Ball Screw operation. It automatically adjusts the mixing ratio of various volumes of dual cartridge type fluid. The Suck Back function of the MMA prevents the dripping phenomenon due to the remaining pressure.



Model	MMA
Dispensing Speed	Max. 500ml/sec
Operation Accuracy	0.01mm
Repeat Accuracy	±0.02mm
Operation Metion	SERVO/STEP
Power	AC220V 50-60Hz 250W

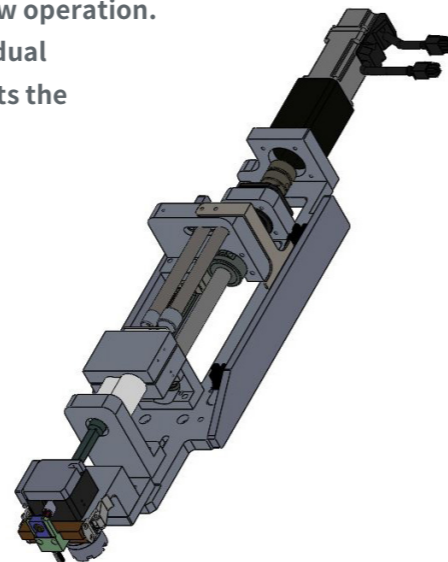

SYRINGE PUMP

BS-1

A syringe type dispensing pump to control low viscosity fluid used in the application as bio-technology. The low viscosity fluids are controlled by the STEP motor using its syringe. The unit provides the best resolution of 2,000:1 with an error rate of 1%.



Model	BS-1	
Power requirements	Voltage	24 VDC
	Current	1 amp maximum
Syringes	Sizes	25ul, 50ul, 100ul, 250ul, 500ul, 1ml, 2.5ml, 5ml, 10ml, 25ml
	Fluid contact	Glass, PTFE, CTFE, UHMWPE
Syringe drive	Drive type	DC stepper motor: self lubricating and wear compensating lead nut/screw
	Travel/speed	2 to 60 seconds/stroke
	Resolution	Half 1,000 counts, Full 2,000 counts
	Accuracy	±1.0% > 30% stroke
	Precision	+0.2% > 30% stroke
Valve drive	Valves	Ceramic or rotating plug
	Drive type	Stepper motor with encoder
	Speed	500 ms 90°
	Fluid contact	PTFE & CTFE or ceramic
Environment	Fittings	1/4 - 28
	Operating temperature	60°F to 95°F (15°C to 25°C)
	Operating humidity	20% to 90%, non-condensing

GEAR PUMP COMPOUND UNITS

The units that can be controlled with a dispensing error of less than 1% by combining Banseok's various & verified equipments with Gear Pump.

PGP-20-10

A gear pump compounded PCP-20-10 which supplies the material pumped from the 20kg can to the Gear Pump stage directly and dispenses the high viscosity fluid material up to 400,000 cps with a precise dispensing accuracy of 1%.



BRGP

A gear pump compounded 330ml cartridge pump. The fluid in the 330ml cartridge transfers directly to the Gear Pump stage and is supplied to the valve using the SERVO motor of the Gear Pump. Suitable for dispensing high viscosity fluid material in the 330ml cartridge, without the loss of fluid material or pulsation.



TAD-175G

TAD-175G is a Gear Pump dispensing system which is directly connected to the fluid supplying unit. A Gear Pump using a SERVO motor dispenses the fluid material with 1% of high accuracy without pulsation.

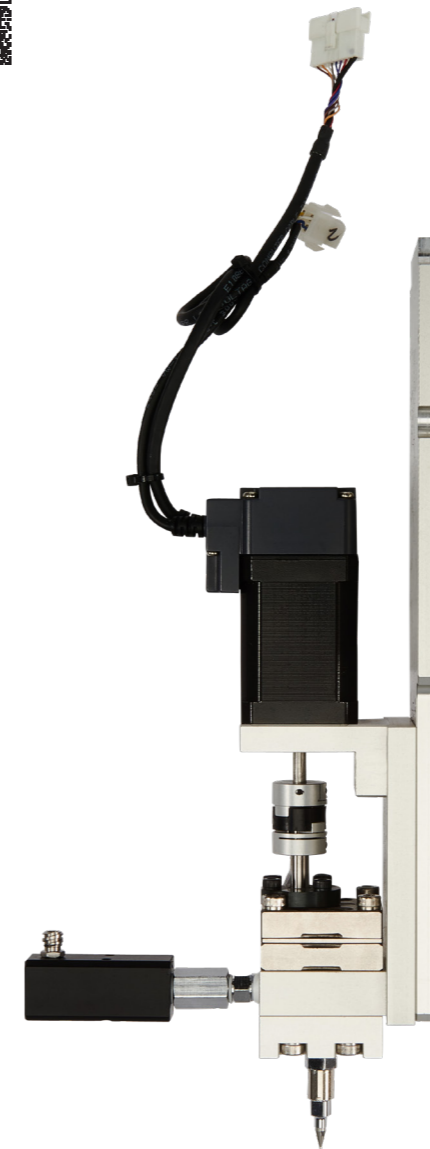

Model	PGP-20-10 / BRGP
cc/Rev	Customizing
Inlet Pressure	Max.2MPa(Max.20kgf/cm ²)
Outlet Pressure	Max.5MPa(Max.50kgf/cm ²)
Viscosity	10,000~400,000cps
Precision	±2%
Power Source	AC220C,50/60Hz
Material	Alloy Tool Steel, Stainless Steel, Aluminium

Model	TAD-175G
Application	Silicone, Urethane, Epoxy, Polyester, Nylon, Polypropylene
Material	High Speed Tool Steel
Weight	1.92kg
Rotation Speed	10~40 Rev/min
Rotation Sense	Clockwise
Inlet Pressure	Max. 50kg/cm ²
Outlet Pressure	Max. 380kg/cm ²
Viscosity of Polymer	1,000~500,000cps

ROBOTS

DESKTOP

BT-200FN



BT-300FN



BT-400FN

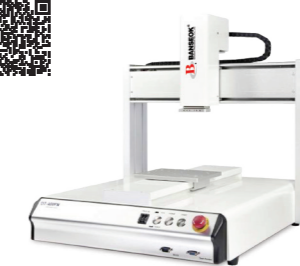

BT-500FN



Model	BT-200FN	BT-300FN	BT-400FN	BT-500FN
Working Area X / Y / Z (mm)	200 / 200 / 50	300 / 300 / 100	400 / 400 / 100	500 / 500 / 100
Load Worktable Y-Axis / Z-Axis	5kg / 3kg	10kg / 5kg	10kg / 5kg	10kg / 5kg
Maximum Speed XY / Z (mm/sec)	0.1 ~ 500 / 300	0.1 ~ 600 / 300	0.1 ~ 600 / 300	0.1 ~ 600 / 300
Resolution	0.001mm / Axis	0.001mm / Axis	0.001mm / Axis	0.001mm / Axis
Repeatability	+/- 0.01mm / Axis	+/- 0.01mm / Axis	+/- 0.01mm / Axis	+/- 0.01mm / Axis
Data Memory Capacity	100 programs 4000 points / program	100 programs 4000 points / program	100 programs 4000 points / program	100 programs 4000 points / program
Display	TFT	TFT	TFT	TFT
Drive System / Stepping Motor	Micro stepping motor	Micro stepping motor	Micro stepping motor	Micro stepping motor
Motion Control	PTP & CP	PTP & CP	PTP & CP	PTP & CP
Linear / Circular Interpolation	3 axis	3 axis	3 axis	3 axis
Teaching Method	Teach pendant	Teach pendant	Teach pendant	Teach pendant
I/O Signals	8 Inputs / 8 Outputs	8 Inputs / 8 Outputs	8 Inputs / 8 Outputs	8 Inputs / 8 Outputs
Power Supply	100 ~ 230 VAC , 200 W	100 ~ 230 VAC , 320 W	100 ~ 230 VAC , 320 W	100 ~ 230 VAC , 320 W
Working Temperature	0 ~ 40°C	0 ~ 40°C	0 ~ 40°C	0 ~ 40°C
Relative Humidity (no condensation)	20 - 90% No condensation	20 - 90% No condensation	20 - 90% No condensation	20 - 90% No condensation
Dimensions (WxDxH mm)	382 × 374 × 485	482 × 499 × 593	585 × 599 × 597	685 × 698 × 593
Robot Weight	23kg	30kg	40kg	45kg

ROBOTS

DESKTOP

BT-500Q2Y



Model	BT-500Q2Y
Working Area X / Y1 / Y2 / Z (mm)	500 / 500 / 500 / 100
Load Worktable Y-Axis / Z-Axis	5 kg / 5 kg
Maximum Speed XY / Z (mm/sec)	0.1 ~ 600 / 300
Resolution	0.001 mm / Axis
Repeatability	+/- 0.01 mm / Axis
Data Memory Capacity	100 programs · 4000 points / program
Display	TFT
Drive System / Stepping Motor	Micro stepping motor
Motion Control	PTP & CP
Linear / Circular Interpolation	3 axis / 2Y
Teaching Method	Teach pendant
I/O Signals	8 Inputs / 8 Outputs
Power Supply	100 ~ 230 VAC , 320 W
Working Temperature	0 ~ 40° C
Relative Humidity (no condensation)	20 - 90% No condensation
Dimensions (WxDxH mm)	685 x 715 x 670
Robot Weight	70 kg

BT-HR Series



Model	BT-300HR	BT-400HR	BT-500HR
Working Area X / Y / Z (mm)	300 / 300 / 100 / 360°	400 / 400 / 100 / 360°	500 / 500 / 100 / 360°
Load Worktable Y-Axis / Z-Axis	10 kg / 2 kg	10 kg / 2 kg	10 kg / 2 kg
Maximum Speed XY / Z (mm/sec)	0.1 ~ 500 / 300	0.1 ~ 500 / 300	0.1 ~ 500 / 300
Resolution	0.001 mm / Axis	0.001 mm / Axis	0.001 mm / Axis
Repeatability	+/- 0.02 mm / Axis	+/- 0.02 mm / Axis	+/- 0.02 mm / Axis
Data Memory Capacity	100 programs · 4000 points / program	100 programs · 4000 points / program	100 programs · 4000 points / program
Display	TFT	TFT	TFT
Drive System / Stepping Motor	servo motor	servo motor	servo motor
Motion Control	PTP & CP	PTP & CP	PTP & CP
Linear / Circular Interpolation	3 axis	3 axis	3 axis
Teaching Method	Teach pendant	Teach pendant	Teach pendant
I/O Signals	8 Inputs / 8 Outputs	8 Inputs / 8 Outputs	8 Inputs / 8 Outputs
Power Supply	AC110 ~ 220 VAC , 300 W	AC110 ~ 220 VAC , 300 W	AC110 ~ 220 VAC , 300 W
Working Temperature	0 ~ 40° C	0 ~ 40° C	0 ~ 40° C
Relative Humidity (no condensation)	20 - 90% No condensation	20 - 90% No condensation	20 - 90% No condensation
Dimensions (WxDxH mm)	485 x 505 x 797	585 x 605 x 797	685 x 698 x 797
Robot Weight	37 kg	47 kg	55 kg

ROBOTS

DESKTOP

BT-S Series



Model	BT-320S	BT-420S
Working Area X / Y / Z (mm)	320 / 350 / 100	420 / 350 / 100
Load Worktable Y-Axis / Z-Axis	10 kg / 5 kg	10 kg / 5 kg
Maximum Speed XY / Z (mm/sec)	0.1 ~ 600 / 300	0.1 ~ 600 / 300
Resolution	0.001 mm / Axis	0.001 mm / Axis
Repeatability	+/- 0.01 mm / Axis	+/- 0.01 mm / Axis
Data Memory Capacity	100 programs · 4000 points / program	100 programs · 4000 points / program
Display	TFT	TFT
Drive System / Stepping Motor	DC servo motor	DC servo motor
Motion Control	PTP & CP	PTP & CP
Linear / Circular Interpolation	3 axis	3 axis
Teaching Method	Teach pendant	Teach pendant
I/O Signals	8 Inputs / 8 Outputs	8 Inputs / 8 Outputs
Power Supply	100 ~ 230 VAC , 320 W	100 ~ 230 VAC , 320 W
Working Temperature	0 ~ 40° C	0 ~ 40° C
Relative Humidity (no condensation)	20 - 90% No condensation	20 - 90% No condensation
Dimensions (WxDxH mm)	482 x 499 x 593	585 x 599 x 597
Robot Weight	30 kg	40 kg

BT-LV Series



Model	BT-320LV	BT-420LV
Working Range X / Y / Z (mm)	320 / 350 / 100	420 / 350 / 100
Load Worktable Y-Axis / Z-Axis	10 kg / 5 kg	10 kg / 5 kg
Maximum Speed XY / Z (mm/sec)	0.1 ~ 500 / 300	0.1 ~ 500 / 300
Resolution	0.001 mm / Axis	0.001 mm / Axis
Repeatability	+/- 0.01 mm / Axis	+/- 0.01 mm / Axis
Data Memory Capacity	4000 points / program	4000 points / program
Program Display	19" LCD Monitor	19" LCD Monitor
Data Storage Type	PC HD Storage	PC HD Storage
Drive System / Stepping Motor	X / Y-axis DC servo motor, Z-axis High resolution stepping motor	X / Y-axis DC servo motor, Z-axis High resolution stepping motor
Driver System	X / Y / Z axis ball screw driven	X / Y / Z axis ball screw driven
Motion Control	PTP & CP	PTP & CP
Linear / Circular Interpolation	3 axis	3 axis
Programming Method	Windows software	Windows software
I/O Signals	8 Inputs / 8 Outputs	8 Inputs / 8 Outputs
Power Supply	100 ~ 230 VAC , 320 W	100 ~ 230 VAC , 320 W
Working Temperature	0 ~ 40° C	0 ~ 40° C
Relative Humidity (no condensation)	20 - 90% No condensation	20 - 90% No condensation
Dimensions (WxDxH mm)	558 x 647 x 630	647 x 685 x 597
Robot Weight	60 kg	70 kg

ROBOTS

DESKTOP

MDR Desktop Robot Series



EASYRO DESKTOP ROBOT ①

Model		331	441	3351	4461	
Axis		3 Axis	3 Axis	4 Axis	4 Axis	
stroke(mm)	X1 axis	300	400	300	400	
	X2 axis (R axis)	-(320°)	-(320°)	300	400	
	Y axis	300	400	500	600	
	Z axis	100	100	100	100	
servo motor(W)	X1 axis	100	100	100	100	
	X2 axis (R axis)	-(100)	-(100)	100	100	
	Y axis	100	100	200	200	
	Z axis	100(Brake)	100(Brake)	100(Brake)	100(Brake)	
MAX.Load(kg)	X1 axis	24kg	24kg	24kg	24kg	
	X2 axis (R axis)	-(3kg)	-(3kg)	24kg	24kg	
	Y axis	24kg	24kg	24kg	24kg	
	Z axis	7kg	7kg	7kg	7kg	
MAX.speed	X1 axis	500mm/sec	500mm/sec	500mm/sec	500mm/sec	
	X2 axis (R axis)	-(360°/s)	-(360°/s)	500mm/sec	500mm/sec	
	Y axis	500mm/sec	500mm/sec	500mm/sec	500mm/sec	
	Z axis	500mm/sec	500mm/sec	500mm/sec	500mm/sec	
Repeatability	± 0.02mm		± 0.02mm		± 0.02mm	
controller	inside		inside		inside	

ECORO DESKTOP ROBOT ②

Model		221	331	441	3351	
Axis		3 Axis	3 Axis	3 Axis	4 Axis	
stroke(mm)	X1 axis	200	300	400	300	
	X2 axis (R axis)	- (-)	-(320°)	-(320°)	300	
	Y axis	200	300	400	500	
	Z axis	50	100	100	100	
step motor	X1 axis	56 *42mm	56 *76mm	56 *76mm	56 *76mm	
	X2 axis (R axis)	- (-)	-(56*76mm)	-(56*76mm)	56 *76mm	
	Y axis	56 *76mm	56 *76mm	56 *76mm	56 *76mm	
	Z axis	56 *76mm	56 *76mm	56 *76mm	56 *76mm	
MAX.Load(kg)	X1 axis	10kg	10kg	10kg	10kg	
	X2 axis (R axis)	-	-(3kg)	-(3kg)	10kg	
	Y axis	15kg	15kg	15kg	15kg	
	Z axis	5kg	5kg	5kg	5kg	
MAX.speed	X1 axis	450mm/sec	450mm/sec	450mm/sec	450mm/sec	
	X2 axis (R axis)	- (-)	-(360°/s)	-(360°/s)	450mm/sec	
	Y axis	450mm/sec	450mm/sec	450mm/sec	450mm/sec	
	Z axis	100mm/sec	200mm/sec	200mm/sec	200mm/sec	
Repeatability	± 0.1mm		± 0.1mm		± 0.1mm	
controller	inside		inside		inside	

ROBOTS

ANY CARTESIAN

Any Cartesian Series

Any cartesian series is a robot dispensing system that is excellent for dispensing applications that require mass production of large-sized products at high speed. It is a customized solution for customer applications that can be selected in combination with various forms in response to various processes. The combination of AC servomotor, ball screw, and LM guide enables high-speed and high-accuracy work. It provides product specifications of Repeatability ± 0.02 and payload of min 21kg~max 100kg.



Robot Multi Head Tool

A multi head tool applied to the robot dispenser. The Barrel, Valve, and Tube can be mounted to the tool, and various types can be selected from one array according to the working process.

MHB	3	5A	30
Micro Holder B: Barrel V: Valve T: Yube	3axis adjuster For manual	Count of Head	Model No. of barrel Model No. of valve Model No. of tube



Micro Holder

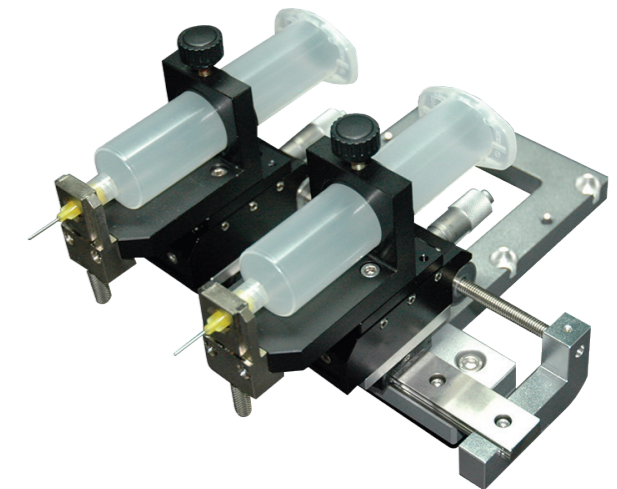

MHB-3-2A-30

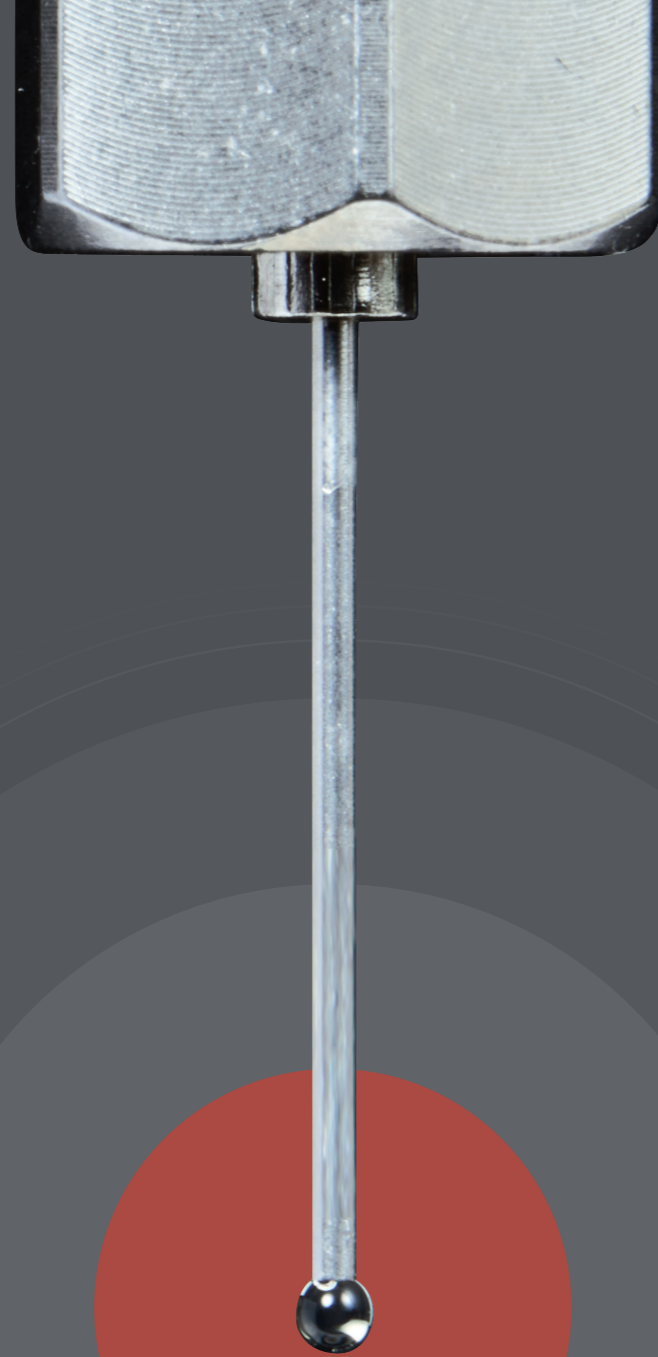

FIRST ONE

This is the first introduction to the world, Banseok developed the Metal Coated Needle on which the fluid don't rise to the needle, therefore provides the optimal dispensing solution.

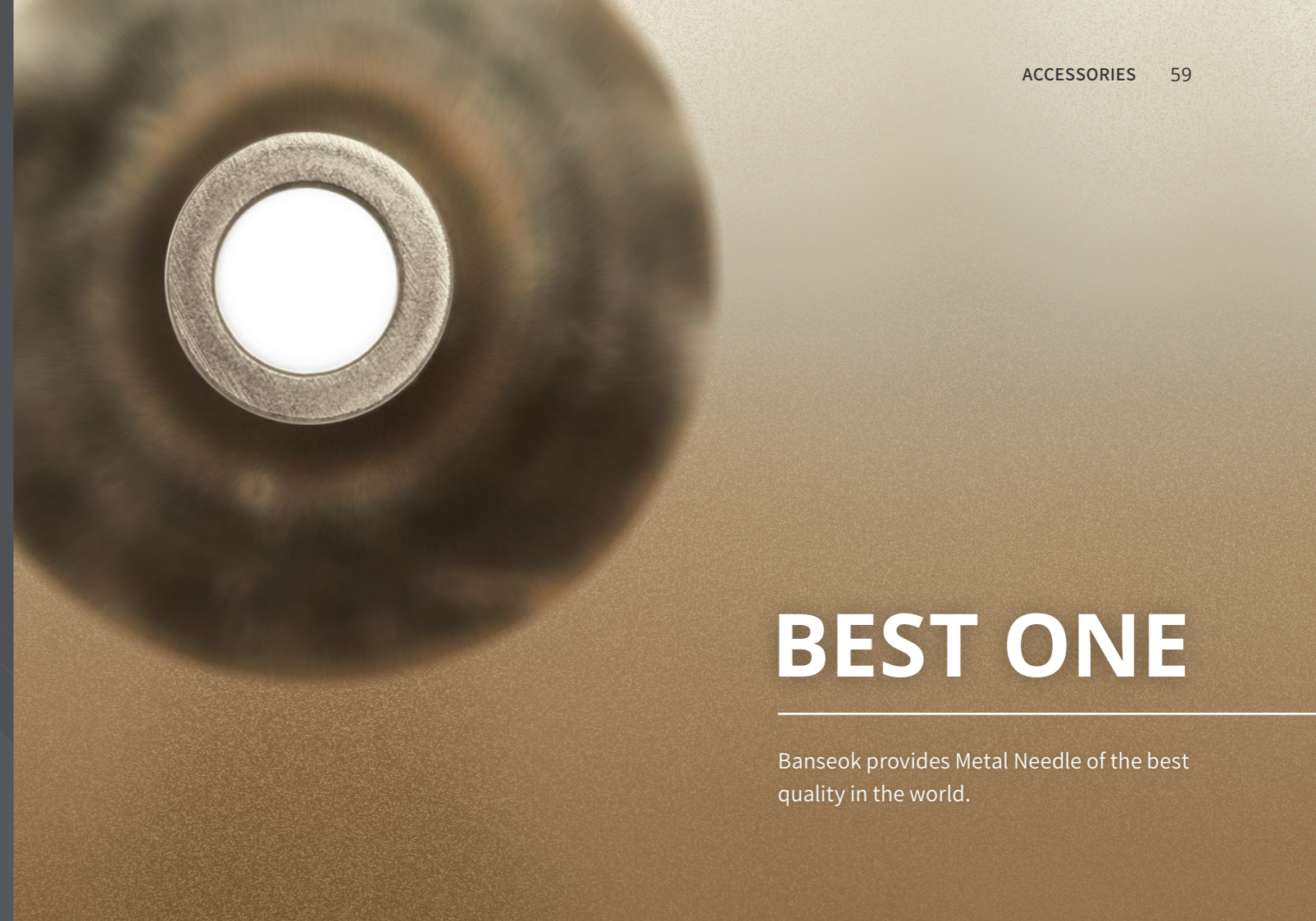

BEST ONE

Banseok provides Metal Needle of the best quality in the world.

ONLY ONE

Banseok provides the only Metal Needle customizing service in the world, providing Metal Needle with the desired shape, function, specifications. Design your own Metal Needle with Banseok.



ACCESSORIES

Metal Coated Needle Manufacturing Technology of Banseok Precision has been completed over the years. Banseok has the technology of self-developed precision assembling equipment, pipe machining, Hub machining, and needle coating which are the world's best quality. The metal needle in dispensing is a basic component used in every application, Banseok has achieved the best precision and quality in the world.

PRECISION METAL NEEDLE

Banseok has developed the world's first trial of Metal needle with the same out diameter with wider in diameter, which enables to improve the dispensing speed and less dripping with high viscosity fluid.



METAL COATED NEEDLE

In order to reduce the inconvenience of cleaning the needle each time after dispensing and the error caused by the needle contamination, Banseok offers the specialized coating option to eliminate the fluid rising on the needle. If the low-viscosity micro dispensing applications failed with previous standard needles from other companies, it is possible to use Banseok's special metal-coated needle.

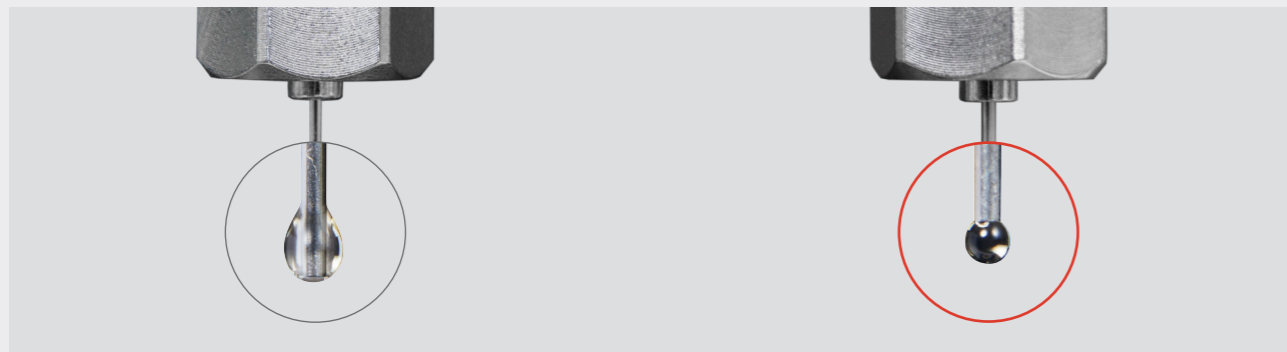

Normal Needle

The fluid material climbs up the needle, causing the contamination on the pipe. This contamination can be discussed when dispensing equal amount.

Metal Coated Needle

A special coated needle eliminated the climbing of the fluid, making the equal quality of dispensing.

Standard type

The highest quality in the world. Standard needle of 13mm long, and order-made lengths are available.

Precision type

It's the world's first attempt and technology. Its outer diameter is same as the standard needle but has a bigger inner diameter. The Drip Free metal needle has the same internal diameter and external diameter as the precision nozzle. If using the high viscosity fluid, the dispensing speed goes significantly slow. Using a drip free metal needle with a bigger inner diameter, you will get a ideal dispensing speed. The needle length is an order-made.



MN-19G



MN-19G-TW



Model	In Dia.	Out Dia.
MN-12G	2.4	2.76
MN-13G	1.9	2.41
MN-14G	1.64	2.1
MN-15G	1.43	1.8
MN-16G	1.2	1.65
MN-17G	1.12	1.48
MN-18G	0.84	1.27
MN-19G	0.69	1.07
MN-20G	0.6	0.91
MN-21G	0.51	0.815
MN-22G	0.41	0.71
MN-23G	0.33	0.635
MN-24G	0.31	0.55
MN-25G	0.25	0.51
MN-26G	0.23	0.45
MN-27G	0.2	0.4
MN-28G	0.18	0.35
MN-29G	0.17	0.33
MN-30G	0.15	0.3
MN-31G	0.13	0.26
MN-32G	0.1	0.23

Model	In Dia.	Out Dia.
MN-14G-TW	1.8	2.1
MN-15G-TW	1.54	1.8
MN-16G-TW	1.37	1.65
MN-17G-TW	1.22	1.48
MN-18G-TW	1.03	1.27
MN-19G-TW	0.84	1.07
MN-20G-TW	0.68	0.91
MN-21G-TW	0.59	0.815
MN-22G-TW	0.5	0.71
MN-23G-TW	0.43	0.635
MN-24G-TW	0.36	0.55
MN-25G-TW	0.33	0.51
MN-26G-TW	0.31	0.45
MN-27G-TW	0.29	0.4
MN-28G-TW	0.25	0.35
MN-29G-TW	0.21	0.33
MN-30G-TW	0.2	0.3
MN-31G-TW	0.16	0.26
MN-32G-TW	0.14	0.23

ACCESSORIES

PLASTIC NEEDLE

The plastic needle is used to dispense the fluid in general.

Needle L = 13mm, 25mm



Model	In Dia	Out Dia	Color
BPN-14G	1.75	2.08	Green
BPN-15G	1.49	1.81	Orange
BPN-16G	1.33	1.63	Purple
BPN-17G	1.15	1.46	White
BPN-18G	0.97	1.25	Pink
BPN-19G	0.77	1.04	Brown
BPN-20G	0.62	0.9	Yellow
BPN-21G	0.54	0.81	Light Green
BPN-22G	0.44	0.71	Black
BPN-23G	0.39	0.63	Light Blue
BPN-24G	0.31	0.55	Red
BPN-25G	0.28	0.5	Blue
BPN-26G	0.24	0.45	Beige
BPN-27G	0.2	0.4	Gray
BPN-30G	0.12	0.3	Lavender

TAPER NEEDLE

The needle useful for dispensing of high viscosity fluids, without damaging on the products.



Model	In Dia.	Color
BTN-14G	1.61	Salmon
BTN-16G	1.22	Gray
BTN-18G	0.89	Green
BTN-20G	0.62	Pink
BTN-22G	0.43	Blue
BTN-24G	0.30	Dark pink

ANGLED NEEDLE

The needle is bent by 45° and is used when dispense is interrupted by the products.



Model	In Dia	Out Dia	Color
BAN-18G	0.84	1.27	Green
BAN-20G	0.6	1.91	Pink
BAN-21G	0.51	1.82	Lavender
BAN-22G	0.41	1.72	Blue
BAN-23G	0.34	1.64	Orange
BAN-25G	0.26	0.51	Red
BAN-27G	0.21	0.41	White

TEFLON NEEDLE

The needle of Teflon materials with chemical resistance and flexibility.

Needle L = 13mm, P = 40mm



Model	Color
BTFN-14G	Green
BTFN-15G	Orange
BTFN-21G	Light Green
BTFN-22G	Black
BTFN-23G	Light Blue
BTFN-26G	Beige
BTFN-30G	Lavender

TEFLON NEEDLE WITH SUS GUIDE

The needle for precise dispensing with chemical resistance. The SUS guide prevents the wavering of the needles.



Model	Teflon	SUS	Color
TN-25G	0.3	1.27	Pink
TN-27G	0.2	0.9	Red



ACCESSORIES

POLYPROPYLENE NEEDLE

The needle with chemical resistance and flexible polypropylene tubing.

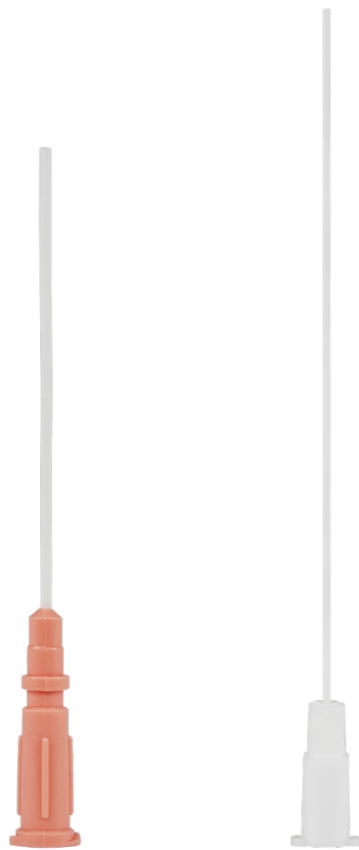

Model	Teflon	SUS	Color
BFN-20G	0.58	0.91	Orange
BFN-22G	0.41	0.71	White

BRUSH NEEDLE

Useful when brushing applications of grease or materials which is not hardened.



Model	Tip Spec
BRN-F	Soft
BRN-BB	Midium
BRN-H	Hard

MIXER PART

If there is a large difference in the mixing ratio between resin and hardener, the static mixer may not perform properly. In this case, the power mixer using the servo motor can mechanically mix the 2K fluid materials.

Mixer element	Description
SME-16.4/10	Ø16.4 × 10 step
SME-16/10	Ø16 × 10 step
SME-12.65/12	Ø12.65 × 12 step
SME-9.4/12	Ø9.4 × 12 step
SME-6.4/16	Ø6.4 × 16 step

Static mixer	Description
SM-12.65/36	Ø12.65 × 36 step
SM-12.65/30	Ø12.65 × 30 step
SM-12.65/24	Ø12.65 × 24 step
SM-12.65/12	Ø12.65 × 12 step
SM-9.4/30	Ø9.4 × 30 step
SM-9.4/24	Ø9.4 × 24 step
SM-6.4/16	Ø6.4 × 16 step
SM-5.4/7	Ø5.4 × 7 step
SM-3/7	Ø3 × 7 step

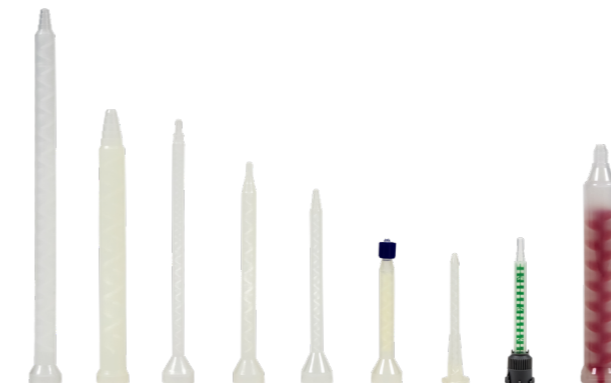

Mixers

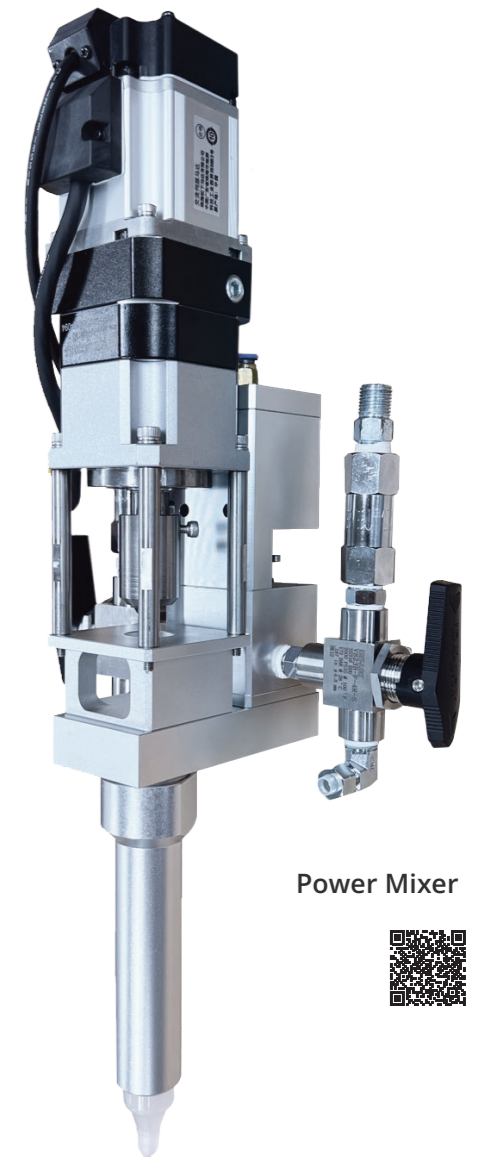

Power Mixer



ACCESSORIES

PRECISION NOZZLE / HIGH QUALITY PRECISION NOZZLE

Precision Nozzle / High Quality Precision nozzle

The nozzle used for precise dispensing of high viscosity fluids.



Precision Nozzle	In Dia
PN-0.3S	0.3
PN-0.4S	0.4
PN-0.5S	0.5
PN-0.6S	0.6
PN-0.7S	0.7
PN-0.8S	0.8
PN-0.9S	0.9
PN-1.0S	1
PN-1.1S	1.1
PN-1.2S	1.2



High Quality Precision Nozzle	In Dia
PN-0.2A	0.2
PN-0.25A	0.25

Teflon Precision Nozzle

A teflon material precision nozzle for the anaerobic fluid application.



Model	In Dia
PN-0.4T	0.4
PN-0.8T	0.8

Precision Nozzle-Luer Lock Type

A precision nozzle designed to be mounted directly to the luer lock type valve.



Model	In Dia
JPNO-0.1	0.1
JPNO-0.15	0.15

Precision Nozzle-Ruby Type

A Precision nozzle which are made with Ruby to tolerate the highly frictional fluid materials while maintaining high thermal conductivity.



Model	In Dia
JPNR-0.15	0.15

TWIN METAL NEEDLE

The needle designed for 2 points of simultaneous dispensing.

Needle L = 20mm, P = 2.5mm



Model	In Dia	Out Dia
BDN-17G	1.12	1.48
BDN-18G	0.84	1.27
BDN-19G	0.64	1.07
BDN-20G	0.69	0.91
BDN-21G	0.60	0.82
BDN-22G	0.51	0.71
BDN-23G	0.41	0.64
BDN-24G	0.33	0.55
BDN-25G	0.25	0.51
BDN-26G	0.23	0.45

Multi Metal Needle

The needle used when applying multi points. An order-made product according to user's application

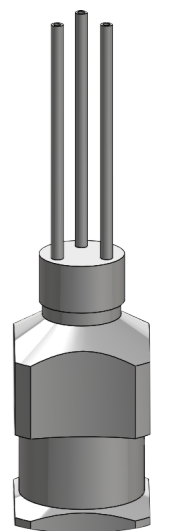

ACCESSORIES

BARREL

This highly precise barrels for dispensing are designed to stand high pressure considering the fluid's flow property. The barrel is designed to dispense high viscosity fluid with no remains. The shape and the material are considered for the safety.



CARTRIDGE

Larger volume of fluid material than barrel can be used with cartridge. Or the fluid material provided in cartridge can be used directly in cartridge holder. The standard specification is 170 / 340 / 600 / 950cc.



	Cartridge	Holder	Plunger	Cap
170cc	CR-170	CH-170	CP-170	CC-170
340cc	CR-340	CH-340	CP-340	CC-340
600cc	CR-600	CH-600	CP-600	CC-600
950cc	CR-950	CH-950	CP-950	CC-950

BARREL ACCESSORIES

PISTON

The piston plunges material filled in the barrel with no remains. Three kinds regarding the viscosity are available. High viscosity (H; Light blue), Low viscosity (L: white), Air-contact prevention (R: Rubber).



TOP CAP

Top cap is used to close the top of the barrel when storing fluids after use.



TIP CAP

Tip cap is used to close the bottom of all kinds of the barrel.



O-RING

O-Ring is used for sealing the barrel and adapter.



HAND SWITCH (BS-H3)

The convenient hand switch attached to the barrel can be operated manually.



FOOT SWITCH

The convenient foot switch attached to the controller can be operated manually.



BARREL STAND (BS-101)



PICK UP PEN (MN-5)

For TAD-200SP

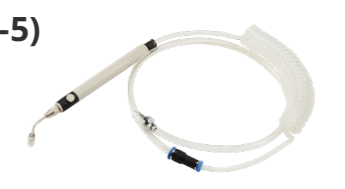

PENCIL SWITCH (MN-7)

For BX-2



NOZZLE FOR MN-7 (MN-7N-00G)

For BX-2



ACCESSORIES

REGULATOR SET

Air regulator

Air regulator sets and displays the air pressure that is supplied to containers.

BR-10K (S:0~10kg/cm², Standard)

BR-04K (L:0~4kg/cm², Low pressure)



Filter regulator

Filter regulator cleans the air and supplies to the dispenser.



TEFLON TUBE(UV) / SILICONE TUBE

For tubing dispenser(BX-2).



Teflon Tube(UV)



Silicone Tube

AWG	In×Out Dia	Type	AWG	In×Out Dia	Type
TT-30G	0.3 × 0.6	M	TT-11G	2.4 × 3.0	T
TT-26G	0.5 × 1.0	S	TT-10G	2.7 × 3.3	T
TT-24G	0.6 × 1.1	S	TT-9G	3.0 × 3.6	T
TT-22G	0.7 × 1.2	S	TT-8G	3.3 × 3.9	T
TT-20G	0.9 × 1.5	T	TT-7G	3.8 × 4.4	T
TT-19G	1.0 × 1.6	T	Silicone tube	0.5 × 2.5	G
TT-18G	1.1 × 1.7	T	Silicone tube	3.0 × 5.0	G
TT-17G	1.2 × 1.8	T	Silicone tube	8.0 × 10	G
TT-16G	1.4 × 2.0	T	TT-24B (UV)	0.6 × 1.0	S
TT-15G	1.6 × 2.2	T	TT-19B (UV)	1.0 × 1.6	T
TT-14G	1.7 × 2.3	T	TT-16B (UV)	1.4 × 2.0	T
TT-13G	1.9 × 2.5	T	TT-13B (UV)	1.9 × 2.5	T
TT-12G	2.2 × 2.8	T			

APPLICATION

IN-LINE AUTOMATION SYSTEM



5AXIS ROBOT DISPENSING SYSTEM



APPLICATION

TWO LIQUID TYPE DISPENSING SYSTEM

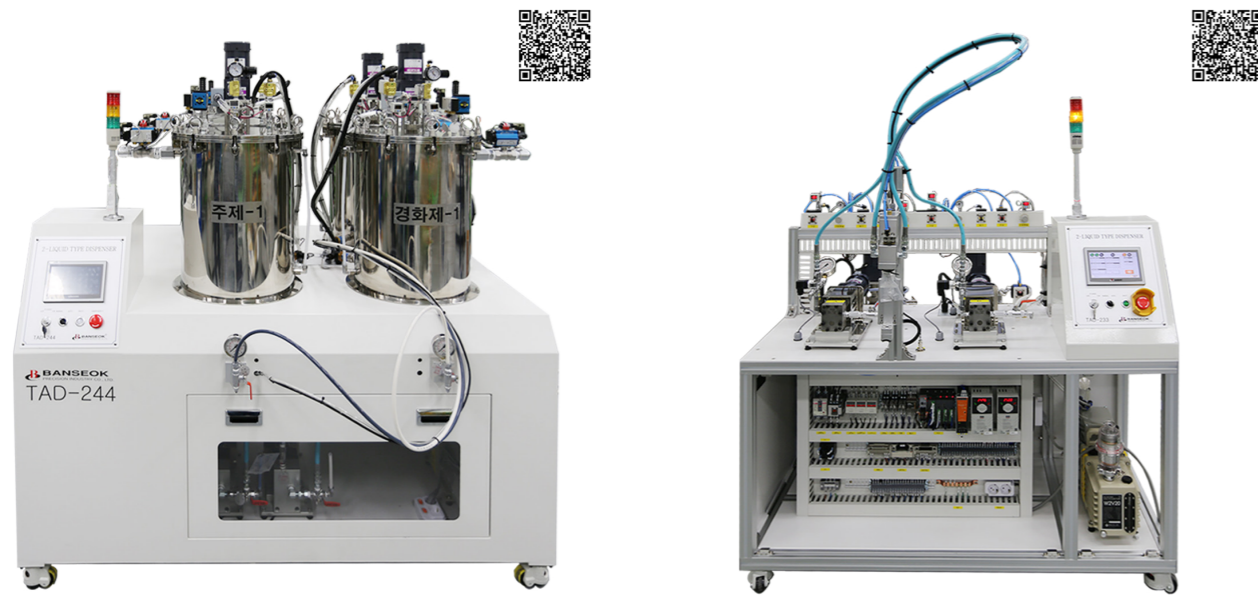

CONFORMAL COATING SYSTEM



HEAD OFFICE/R&D LAB

B101~B104, FORHU, 58, Wangshimni-ro, Seongdong-gu, Seoul, Republic of Korea
TEL. +82-2-469-1239 FAX. +82-2-469-6955

DAEGU BRANCH

305, 3rd Floor, 46, Igokseo-ro, Dalseo-gu, Daegu, Republic of Korea
TEL. +82-10-9263-5910

SHENZHEN BRANCH, CHINA

Room 1306, Mingjun Business Center, No.1 Langrong Road, Dalang Street,
Longhua District, Shenzhen, Guangdong, China
TEL. +86-755-8204-6882 FAX. +86-755-8204-4378

WEBSITE

www.banseok.co.kr

CONTACT

trade@banseok.co.kr(Oversea dept.)

